

MODEL - TRW414
 CAPACITY - 4000LBS
 WEIGHT - 445LBS
 T & P - 15875LBS

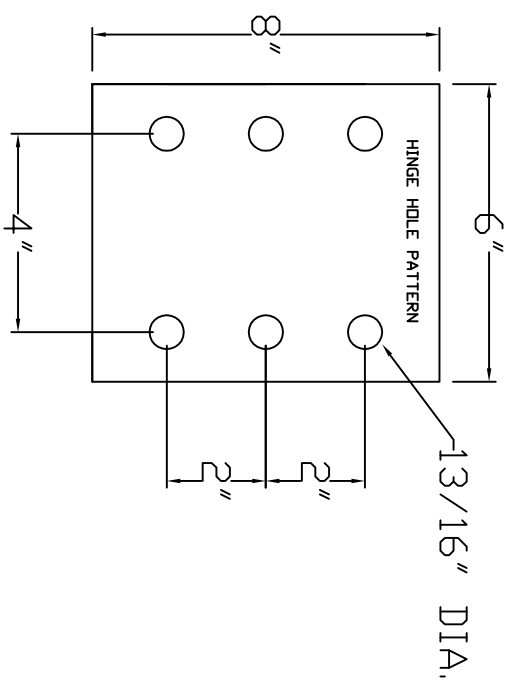

ADEQUACY OF MOUNTING SURFACE DETERMINED BY OTHERS. MOUNTING BOLTS NOT INCLUDED. USE GRADE 5 OR BETTER BOLTS. WEIGHTS ARE ESTIMATED.

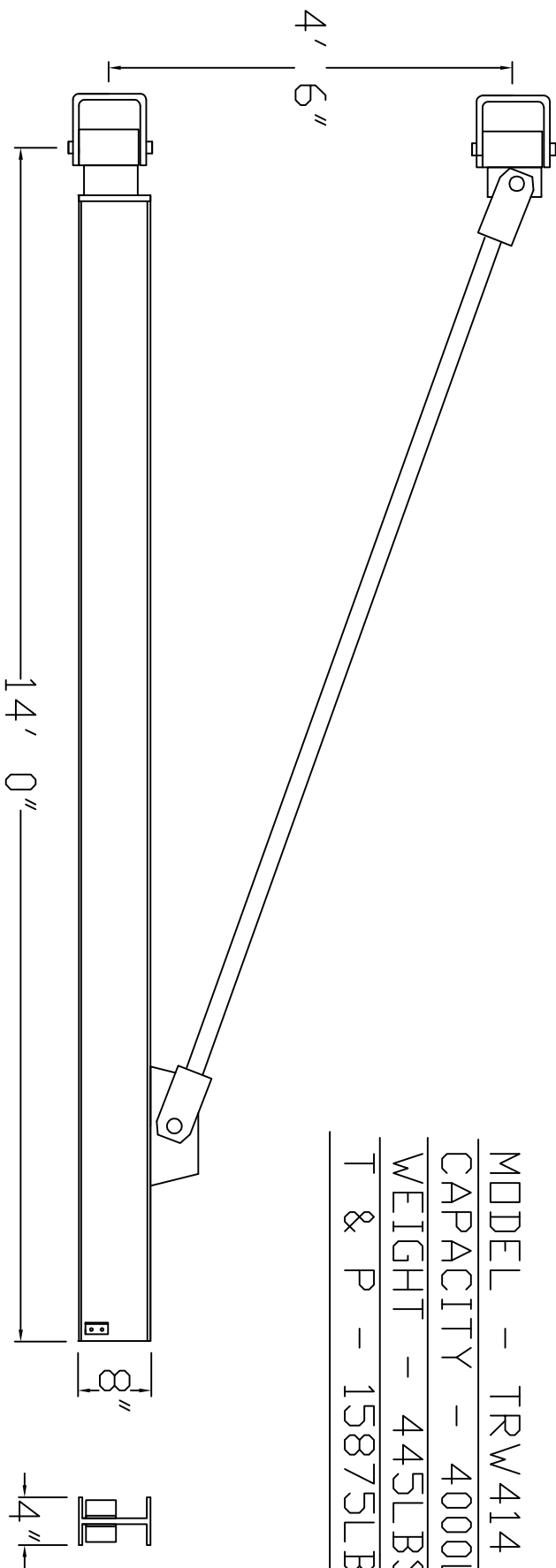

2127 W. NORDALE DR. APPLETON, WI 54914
 PH - 920-380-0397 FAX - 920-380-0845